



EPA300

PROCESS CONTROL DEVICE



USER MANUAL

INDEX

1. TECHNICAL SPECIFICATIONS -----	3
2. MECHANICAL DIMENSIONS -----	4
3. CONNECTIONS -----	5
4. MENU TREE -----	6
5. FRONT PANEL DEFINITIONS -----	7
6. SETUP -----	8
6.1 Connecting the Sensor to the Device-----	8
6.2 Device Calibration-----	9
6.3 Setting the Relay Set Value -----	10
7. OPERATING MODE: FUNCTIONS -----	12
7.1 Tare Function-----	12
7.2 Viewing the Maximum and Minimum Values that are read-----	12
7.3 Changing Quick Set Values -----	13
7.4 Switching the Programming Mode-----	13
8. PROGRAMMING MODE: PROGRAMMING OF THE DEVICE -----	14
8.1 Output Menu [OUT]-----	14
8.1.1 1. Relay Output Settings (OUT-1)-----	16
8.1.2 2., 3., 4. Relay Output Settings(OUT-2-3-4)-----	16
8.1.3 Current and Voltage analog Output Settings (ANLOG)-----	16
8.1.4 UART and CANopen Digital Output Settings (DGTAL)-----	17
8.1.5 Key Tone Setting (SOUND)-----	17
8.2 Calibration Menu[CALIB]-----	18
8.2.1 Specifying Scale Values (SCALE)-----	18
8.2.2 Manual Calibration Method Determination (CALOP)-----	18
8.2.3 Number of Calibration (CL.CNT)-----	19
8.2.4 Automatic Calibration(START)-----	19
8.3 Display Menu [DISP]-----	19
8.3.1 Choice of decimal point location (POINT)-----	19
8.3.2 Tare Function Settings (TARE)-----	19
8.3.3 Screen Refresh Rate (REFRS)-----	20
8.3.4 Blocking the Vibration on the Screen (FILTR)-----	20
8.3.5 Setting the LED Bar-----	21
8.4 Secure Menu [SECUR]-----	21
8.4.1 Hide Menu (HIDE)-----	21
8.4.2 Lock Menu (LOCK)-----	22
8.4.3 Setting the Password (PASS)-----	22
8.4.4 Return to Factory Settings (FTRY)-----	22
8.4.5 Restart the Device (RESET)-----	22
9. WARRANTY DOCUMENT -----	23

1. TECHNICAL SPECIFICATIONS

Supply Voltage	24 V _{AC/DC} 50/60 Hz 85-265 V _{AC} 50/60 Hz	
Power Consumption	9 VA / 2,7 Watt Max.	
Sensor Supply Voltage	Pot:	5 V _{DC}
	mV/V:	10 V _{DC}
	0-10V:	24 V _{DC}
	0-5V:	5 V _{DC}
	0,5-4,5V:	5 V _{DC}
	4-20 mA:	24 V _{DC}
	CANopen:	24 V _{DC}
Max Sensor Supply Current	100 mA	
Sampling Rate	3.5 kHz	
Resolution	16 bit	
Analog Inputs	Potentiometer, 0.5-4.5 V, 0-5 V, 0-10 V, 4-20 mA, 0-20 mA, 3,33 mV/V, 2mV/V, 2,5mV/V Ratiometric	
Relay Outputs	4 pcs. 250 V _{AC} 3A (for resistive load) Relay	
Serial Communications (Optional)	RS-232, RS-485, USB, CANopen	
Analog Outputs (Optional)	0-10 V, 0-5 V, 0.5- 4.5 V, 4-20 mA, 0-20 mA	
Connection	2,5 mm ² terminal with socket	
Operating Temperature	0 °C ... 50 °C	
Storage Temperature	-10 °C ... 60 °C	
Protection Class	IP60 front panel, IP20 back panel	
Weight	~220 gr	
Mounting	It is fixed to the clipboard with the feet on the upper and lower side.	

2. MECHANICAL DIMENSIONS

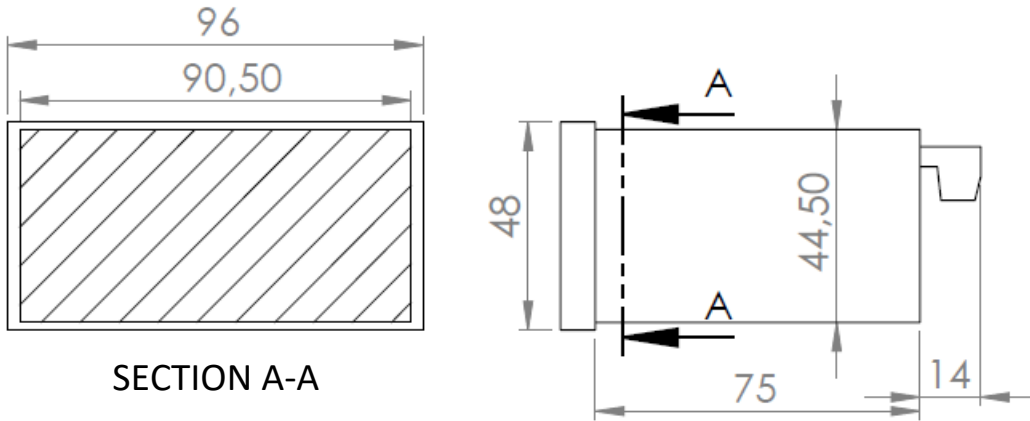

SAFETY WARNINGS



1. Follow the instructions and warnings in the user guide.
2. Please check the power supply type before connects energy to the device.
3. Please the device mounted on panel against dangers of fall, snap, shake during working.
4. Make Sensor connections without energy on the device; do not connect in any way during operation.
5. Make sure that is shielded cables between device and sensor.
6. Do not leave the device exposed to a heat source (solar, heater etc.)
7. EPA300 industrial control device is not suitable for use in the external environment, Use only room conditions.
8. Wipe with a damp cloth to clean the device, do not use water, thinner etc.
9. Comply with the limit values specified in the technical specifications for relay outputs.
10. The device cannot be changed by the user in the event of a fault, Please contact our technical service in case of failure.

3. CONNECTIONS

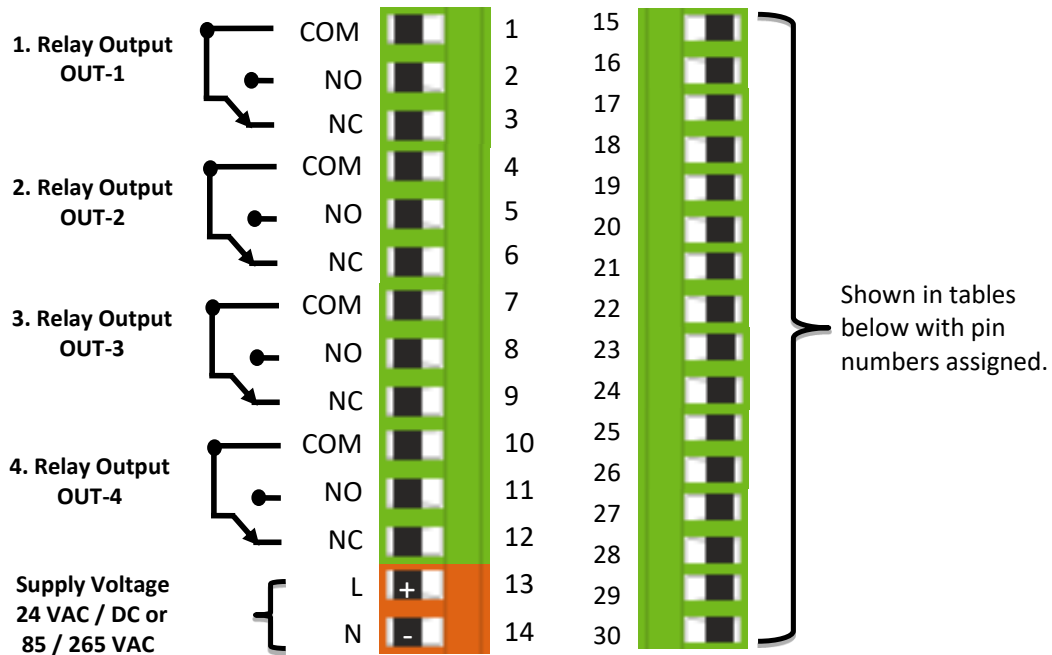

Digital Comm.	28	29	30
RS485	A	B	GND
RS232	Rx	Tx	GND
USB HID	USB CONNECTOR		
USB VIRTUAL	USB CONNECTOR		
CANopen	CAN HIGH	CAN LOW	GND

ANALOG OUTPUTS	20	21	22	23	24*	25*	26*	27*
4-20 mA Output	Signal Output	GND	X	X	Signal Output	GND	Signal Output	GND
0-10 V Output								
0-5 V Output								
0.5-4.5 V Output								
Tare Input	X	X	Tare	GND	X	X	X	X

(*)Connection terminals 24, 25, 26 and 27 are used when the redundant output is desired. There is no signal in these terminals when a single analog output is desired.



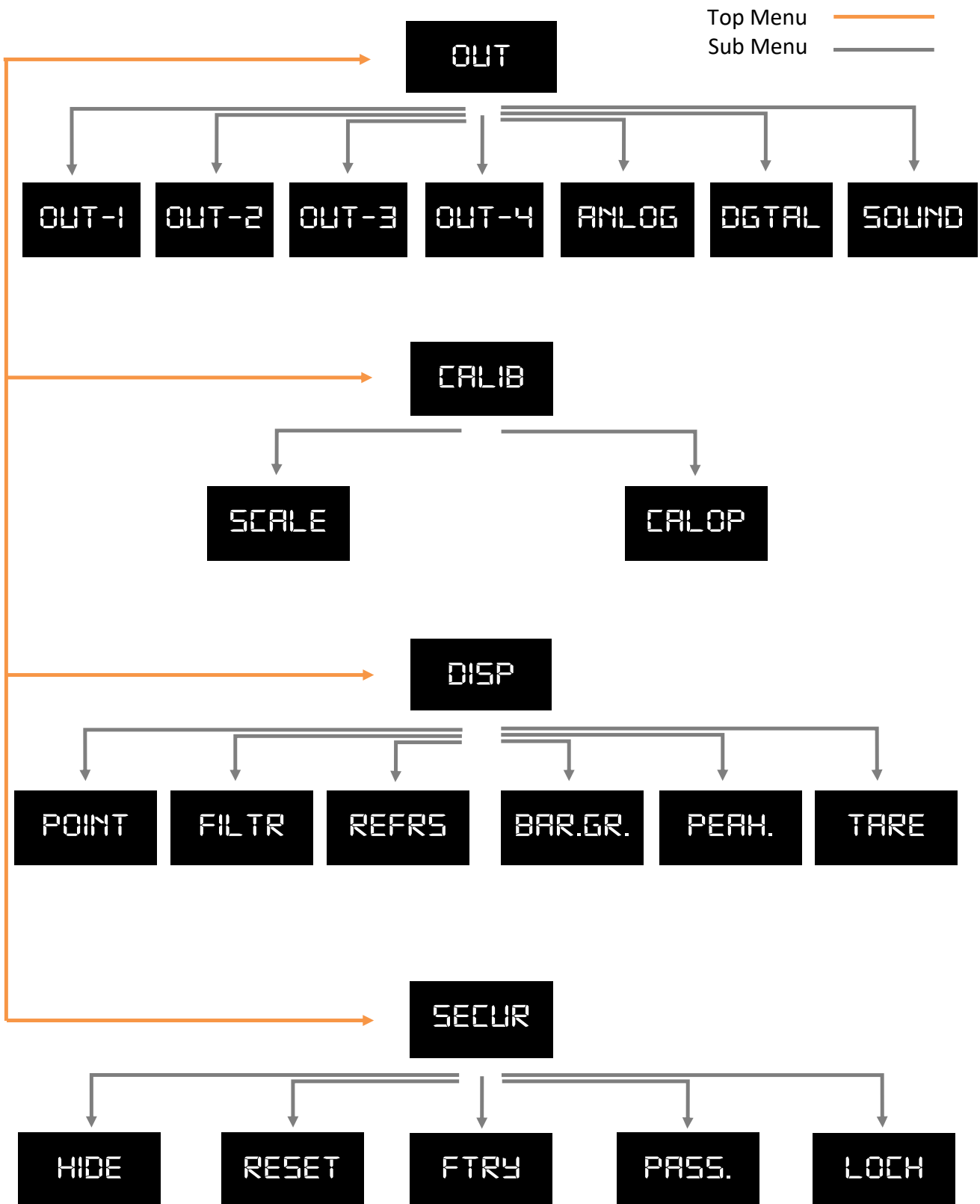

SENSOR INPUT	15	16	17	18	19
Potentiometer	1. tip	2. tip	3. tip	X	X
4-20 mA Input	Supply	Sensor Signal	GND	X	X
0-20 mA Input					
0-10 V Input					
0-5 V Input					
0.5-4.5 V Input					
mV/V Input	Supply	X	GND	Signal(+)	Signal(-)

4. MENU TREE



5. FRONT PANEL DEFINITIONS



- 1) PRG (): Programming and Enter key. It is used to enter the menus or confirm the entered values.
- 2) ESC (): Escape, exit and back key. It is used to return to the upper menu or to exit from the menus.
- 3) UP (): Up key. Used for navigating between menus, incrementing the value when entering a value or moving to upper step.
- 4) DOWN (): Down key. Used for navigating between menus, decreasing the value when entering a value or moving to lower step.
- 5) **Set1** Status LED: Lights up when the relay 1 output is active.
- 6) **Set2** Status LED: Lights up when the relay 2 output is active.
- 7) **Set3** Status LED: Lights up when the relay 3 output is active.
- 8) **Set4** Status LED: Lights up when the relay 4 output is active.
- 9) **Min** Status LED: Lights up when the lowest (minimum) value read from the moment the device starts to operate.
- 10) **Max** Status LED: Lights up when the maximum read value is displayed when the device starts operating.
- 11) **Tare** Status LED: Indicator that is lit when the key function is active.
- 12) Display Screen: Display screen consisting of 5 lines from a single line.
- 13) LED bar: The entered scale values increase and decrease in range.

6. SETUP

6.1 Connecting the Sensor to the Device

Potentiometer connections:

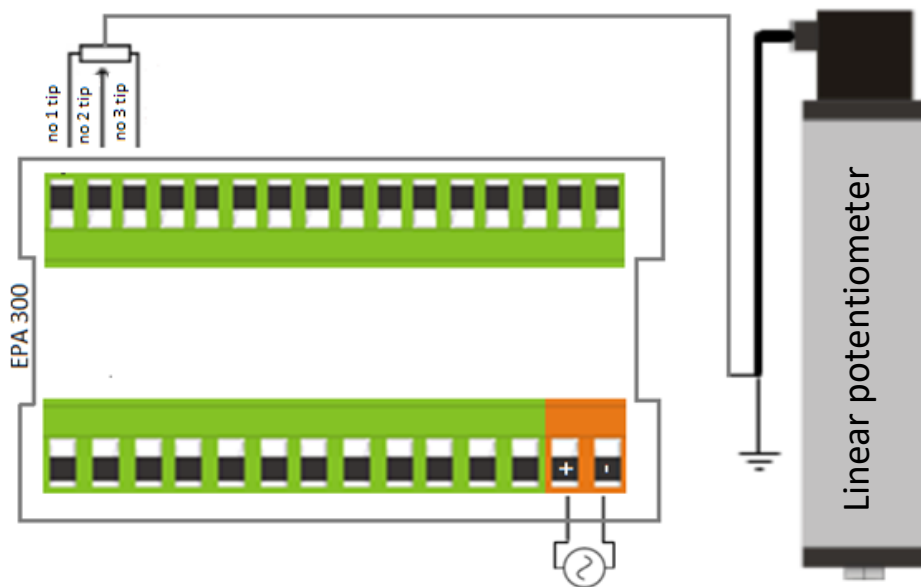

4-20 mA, 0-20 mA or 0.5-4.5 V, 0-5 V, 0-10 V Sensor connections:

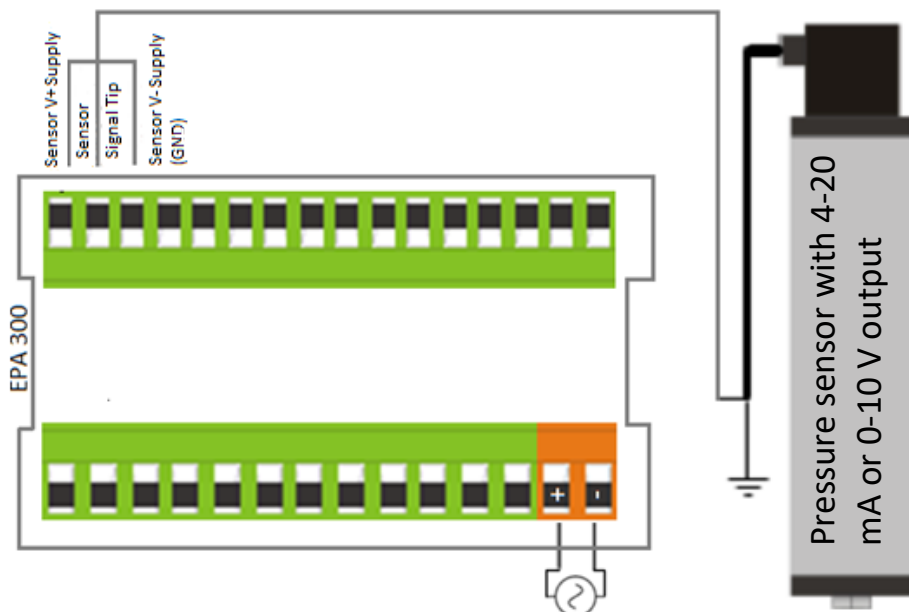

mV/V Ratiometric Sensor connections:

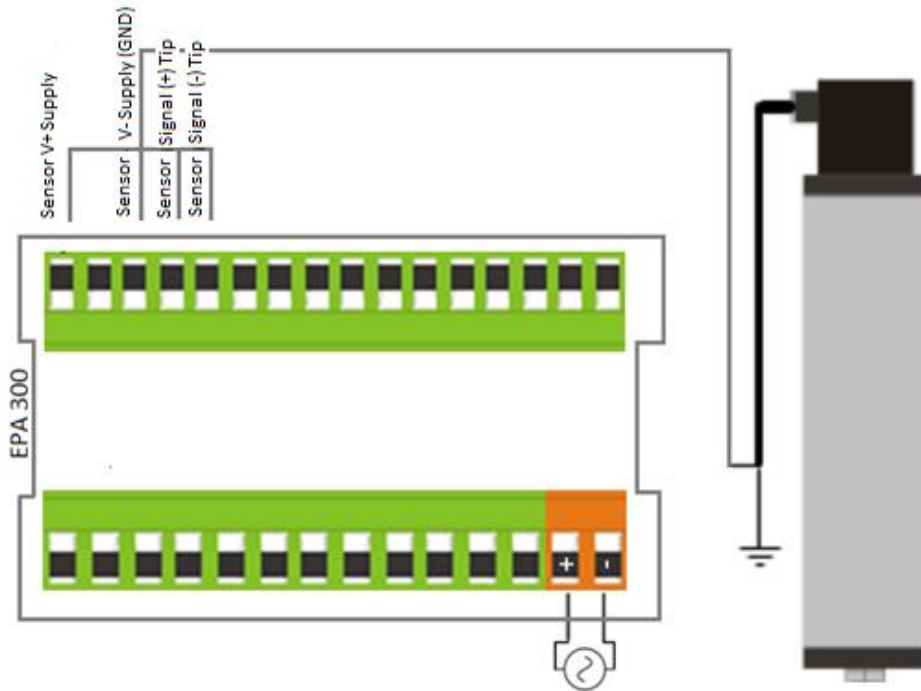

6.2 Device Calibration

Your device is calibrated automatically according to factory settings and operates in the 0-100 value range. That is, on the minimum value read from the sensor is displayed as 0 and the maximum value read from the sensor is displayed as 100, on the display. You can change this scale from the calibration menu. Use S-LO for the minimum value and use S-HI for the maximum value, that will be shown on the display.

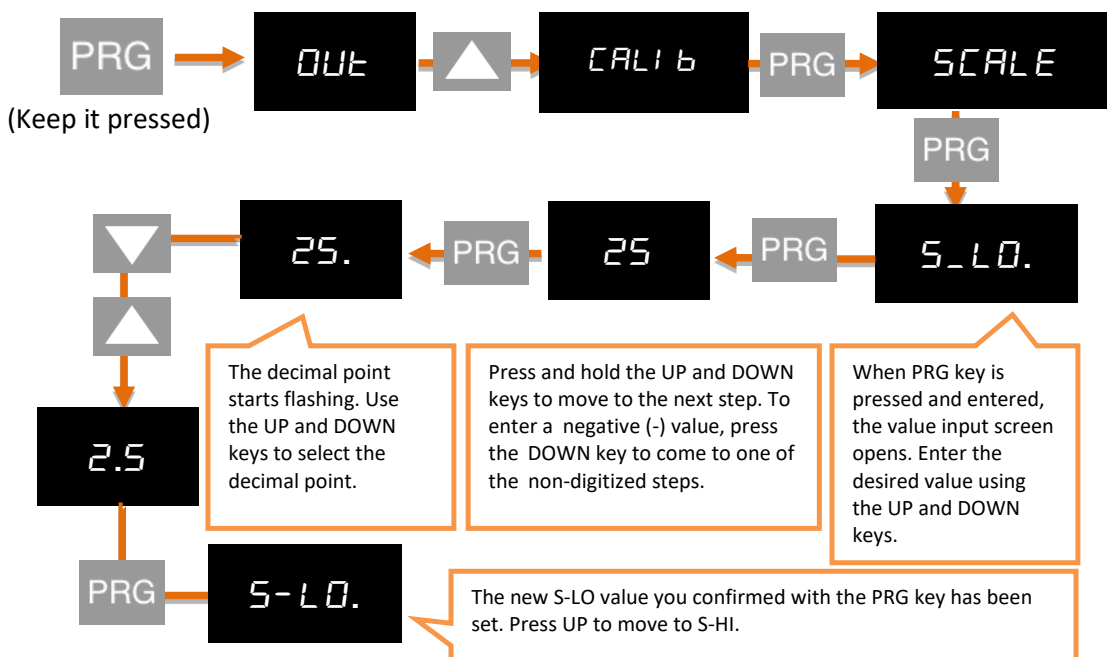

After specifying the S-LO value, you can do the same for the S-HI value.

6.3 Setting the Relay Set Value

Set the SET values for the relay outputs of your device to be activated.

1. Specify SET-1 for relay output:

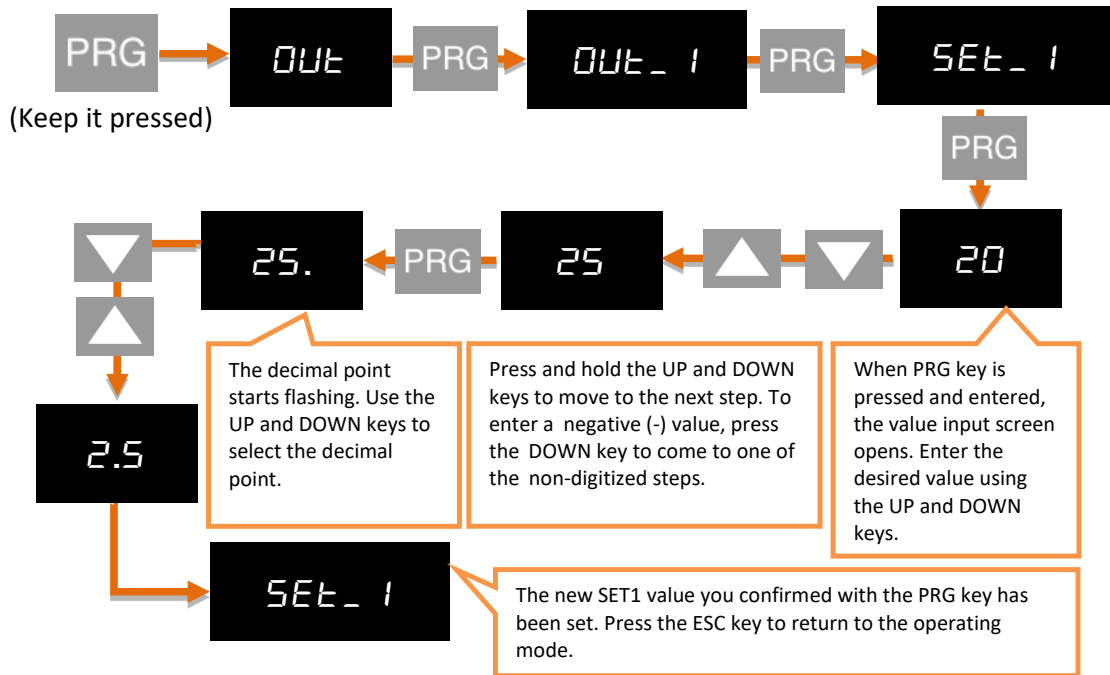

2. Specify SET-2 for relay output:

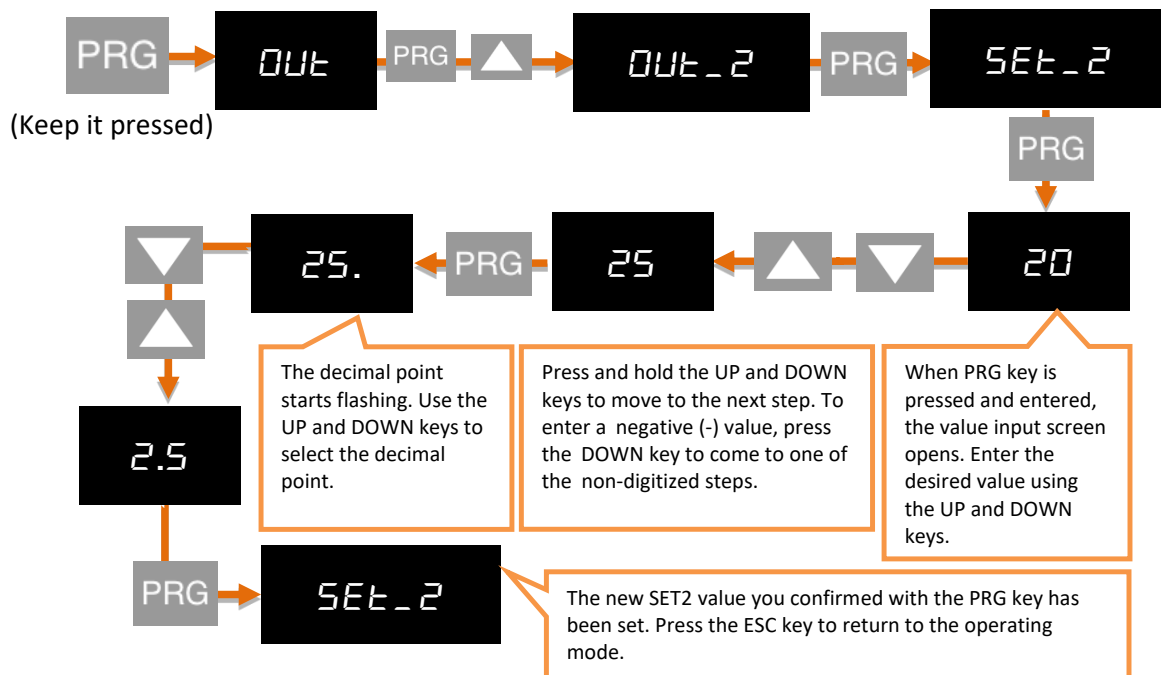

3. Specify SET-3 for relay output:

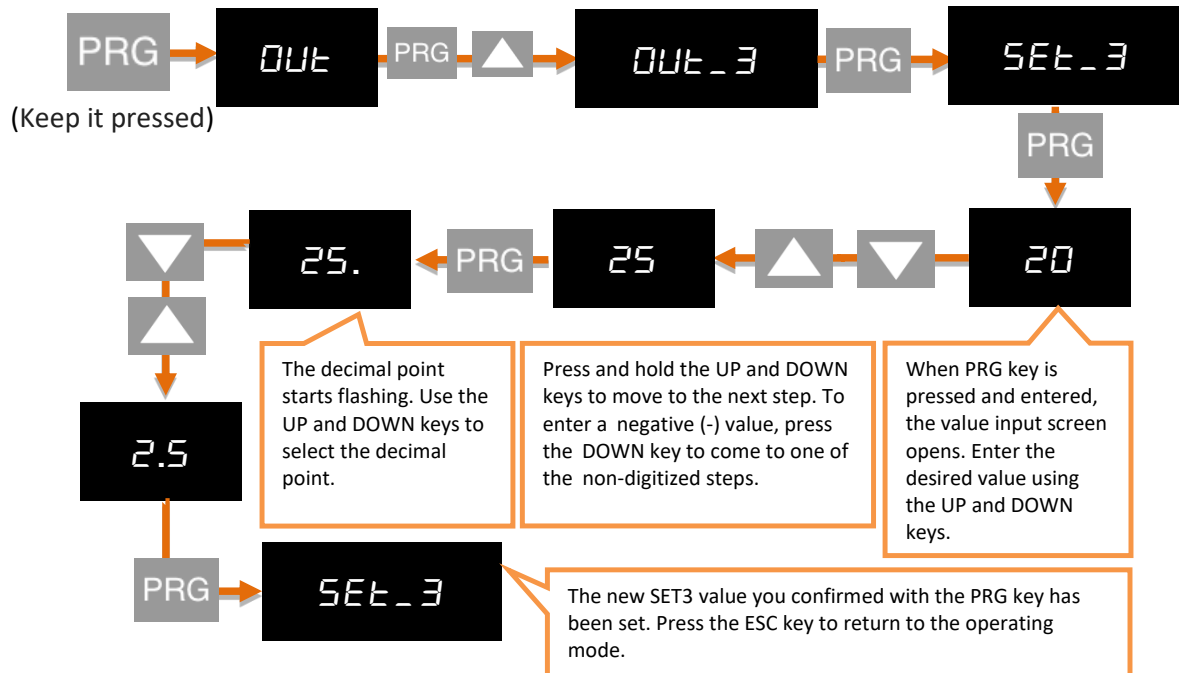

4. Specify SET-4 for relay output:

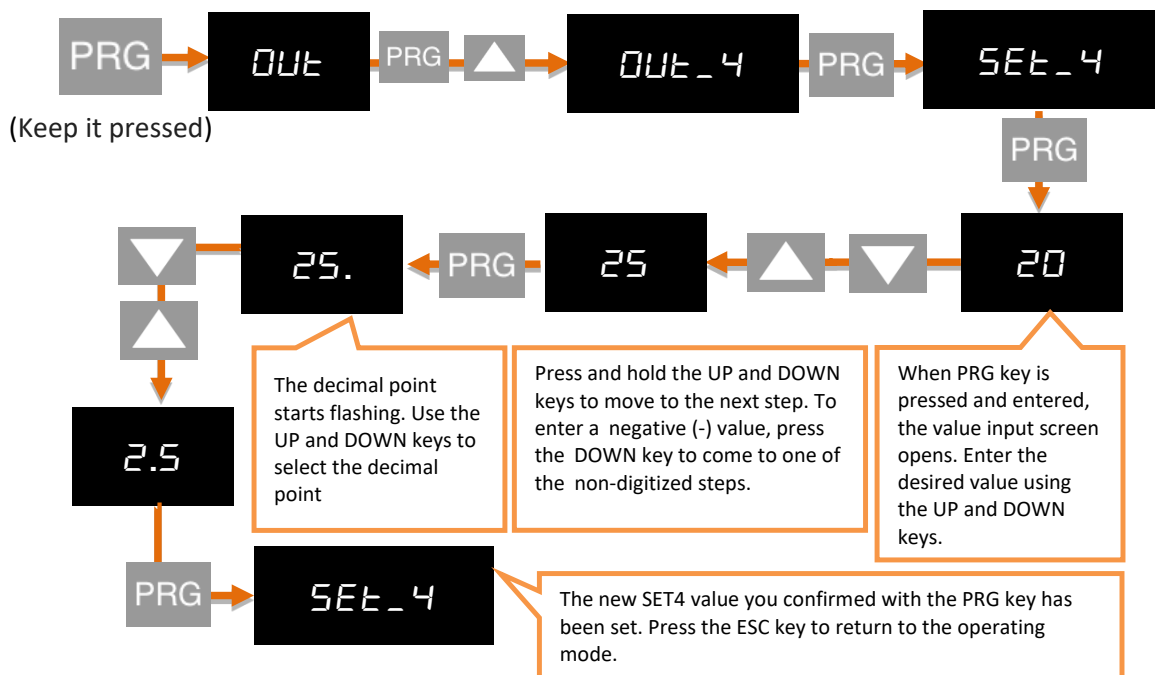

7. OPERATING MODE: FUNCTIONS

Your EPA300 process controller operates in two different modes. Your device is in 'operating mode' while the initial value of the sensor readout is displayed; In the 'programming mode' on the screen where the settings are changed and the parameters are changed. In this section, the functions in operating mode are explained.

7.1 Tare Function

****Only works when the Tare function is active. For activating or explaining the types of functions, 8.3.2 Setting the Tare Function*

Each time the UP key is pressed while the unit is in the operating mode, the Tare function is activated according to the type of the selected function and the **Tare** status lights up.

7.2 Viewing the Maximum and Minimum Values That Are Read

If you press the DOWN key while the unit is in operating mode, you can see the lowest (minimum) value read from the moment the unit starts to operate. At the same time, **Min** status will flash on the screen.

When you press the DOWN key again, you can see the highest (maximum) value read from the moment the device starts to operate. At the same time **Max** will be on the screen.



* You can see Min - Max on the screen for as long as you want and make it active for as long as you want. To make settings for Min – Max menu;



t.Lo. → A value in seconds is entered and the last minimum value is kept on the display for this time. If no value is entered in this menu, the minimum value in memory is valid.

t.H i. → A value in seconds is entered and the last maximum value is kept on the display for this time. If no value is entered in this menu, the maximum value in memory is valid.

t.ESC. → A value in seconds is entered, min. or max. values are kept on the display for the time entered. then the screen returns to the current value. If no value is entered in this menu, min. or max. value remains visible on the screen.

Note: You can use the ESC key to delete the (minimum) or (maximum) values in the memory.

7.3 Changing Quick Set Values

Press and hold the ESC key to quickly change all adjustable setpoints while the unit is in run mode. You can then change the desired SET value by pressing the PRG key. When entering a value, press and hold the UP and DOWN keys to move to the next step. To enter a negative (-) value, press the DOWN key to come to one of the non-digitized steps



7.4 Switching The Programming Mode

To switch your device from working mode to programming mode

Press and hold PRG until OUT appears in the display. To return to the operating mode, press the ESC key repeatedly until you return to the operating mode.

8. PROGRAMMING MODE: PROGRAMMING DEVICE

Your EPA300 process controller operates in two different modes. Your device is in 'operating mode' while the initial value of the sensor readout is displayed; In the 'programming mode' on the screen where the settings are changed and the parameters are changed. In this section, the functions in Programming Mode are explained.

To switch your device from working mode to programming mode Press and hold PRG until OUT appears in the display. To return to the operating mode, press the ESC key repeatedly until you return to the operating mode. While your device is in Programming Mode;

- To scroll between menus, press the DOWN and UP keys
- Press enter (PRG) to enter any menu.
- Use the ESC key to exit from any menu and return to the upper menu.
- When entering any parameter value, press the DOWN key to decrease, press the UP to increase the value. Press and hold the keys to move to the next or previous digit.

The EPA300 consists of 4 main menu items: Output, Secure, Display and Calibration.

8.1 Output Menu [OUT]

8.1.1 1. Relay Output Settings (OUT-1)

OUT - 1

8.1.1.1 Entering the Set Value

The first relay output activates and sets the value of the lit LED of the status SET1.

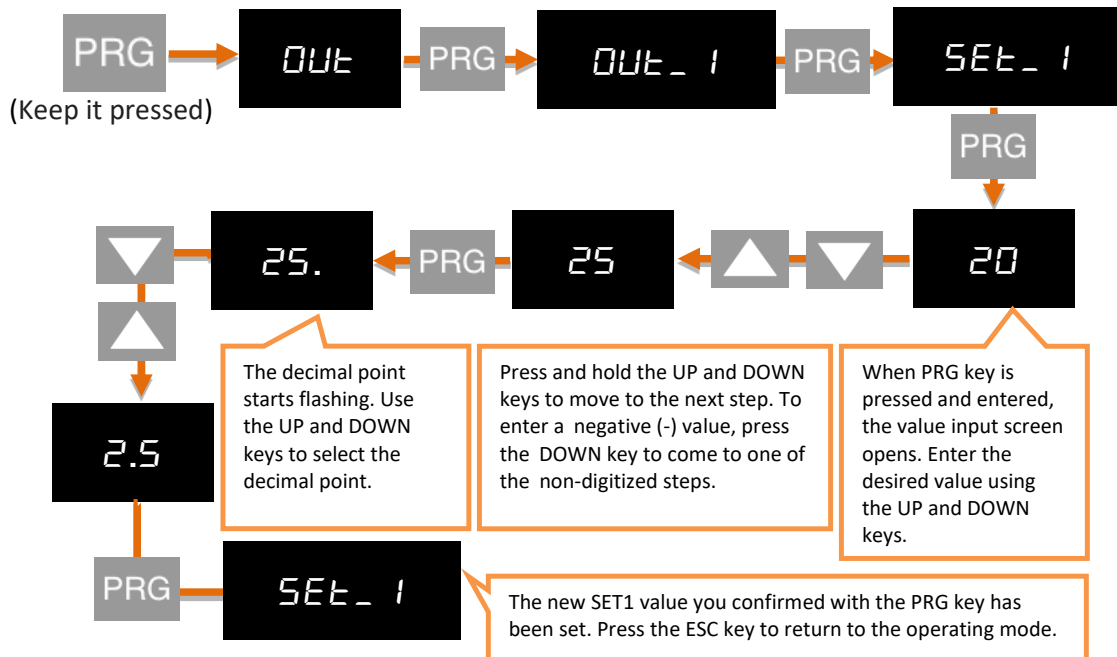

8.1.1.2 Relay Output Function Selection

Funct.

This function selection determines when the relay output will be activated and deactivated according to the set values.

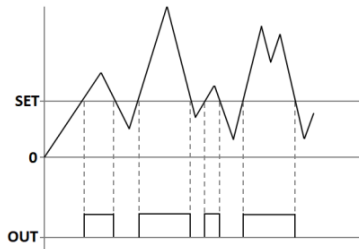

sAnd

The relay is activated when the value read in the device increases by increasing Set-1 value.

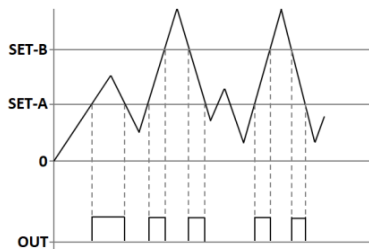

bAnd

The relay is activated when the read value in the device is between Set-1A and Set-1B.

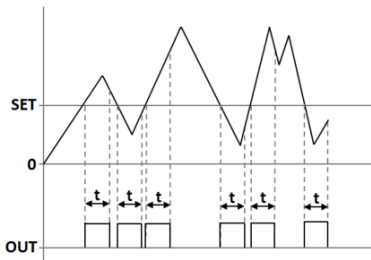

cAtch

The value read in the device is activated whenever the Set-1 value increases or decreases.

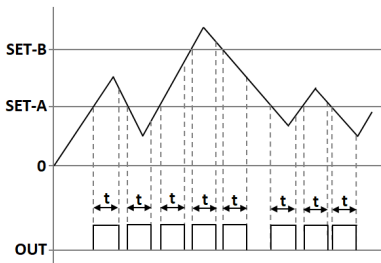

dUAL

The value read in the device activates the relay whenever the Set-1A or Set-1B value increases or decreases.

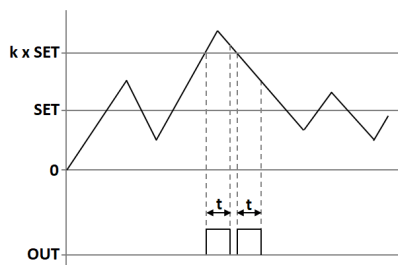

PErdC

The value read in the device is activated when the value of Set-1 or the value of Set-1 is increased or decreased by every level such as 2,3,4,5 ...

8.1.1.3 Delay DELAY

It specifies in seconds how long the relay output will remain active after it is activated. If '0' is entered as a zero value, the relay output will remain active until it changes conditionally.

8.1.1.4 Hysteresis HYSUP HYSdn

Due to the instability in decimal value read on the connected sensor, you can enter the hysteresis value to prevent the relay from being turned on and off at any time, so that the set value you set for the relay will be activated and deactivated as low as Hysdn and above Hysup.

8.1.1.5 Offset Value OFFSET

If you want to add offset to the entered set value, this menu is used. If all set values are selected forward or negative by the specified offset value, they are shifted back.

8.1.1.6 The Default State of the Relay Cond

Depending on the factory settings of your device, the relay is normally closed and activated with the specified setpoint and functions. Use the Cond option on the Out-1 menu to activate the default in the default position and turn off with the specified setpoint and functions. The factory setting NC (NormallyClosed) is the option that the relay is normally closed, NO. (Normally Open) indicates that the relay is normally open.

8.1.2 2., 3., 4.Relay Output Settings (OUT-2-3-4) OUT_2

In this menu you can set the relay outputs 2, 3 and 4 of your EPA300. Complete settings 8.1.1. The 1 st relay output described in chapter is the same as the OUT-1 settings.

8.1.3 Current and Voltage Analog Output Settings (ANLOG) ANLOG

If your EPA300, which is manufactured specifically for your order, has an analog output module, you can make the necessary settings from this menu.

Select the analogue output from the **TYPE** menu:



From the **COND** menu, select whether the analogue output module is active or not. Use ON to activate or OFF to deactivate.

From **InvrS** menu, you can choose which value to increase or decrease according to the sensor reading on the analogue output. This option, which is OFF by default, provides an analog output that increases or decreases in proportion to the value read at the sensor. If you turn this ON, the value read out at the sensor will increase

while the value at the analog output will decrease, ie an inversely proportional output will be provided.

Wave Form (VAVE.F.) **VAVE.F.**

The waveform of the output signal can be selected from the Vave.f menu. There are 4 options in the menu: Liner, Sin, Cos, Trian. When the liner option is confirmed with the PRG key, a linearly increasing waveform is obtained in the specified scale range. When the Cos option is confirmed with the PRG key, a waveform in the form of a waveform that starts from zero and completes a complete cosine wave is obtained at the scale interval specified. When the Sin option is confirmed, a waveform in the form of a waveform that starts at the peak value of the sine wave and completes a complete sinusoidal wave in the determined scale range is obtained. When the triangle option is selected in the same way, a triangle wave is obtained in the scale interval determined at the exact middle value corresponding to the top.

Analog Output Scale Setting (Scale) **SCALE**

In the device with the analogue output feature, SCALE mode in this menu must be ON to set the output signal to the desired scale range. S-LO started appearing on the analogue menu afterwards. And S-HI. Options and scale values can be entered.

8.1.4 UART and CANopen Digital Output Settings (DGTL) **DGTL**

WARNING: After changing the UART or CANopen settings, you need to restart the device for the changes to take effect.

If your device has a USB port, use MyPanelMeter, which you can download from our website to check your device. Check the user manual of the program.

8.1.4.1 UART Settings

If you are communicating with your device via RS-485 or RS-232; You can make the necessary settings here. You can select the communication protocol, baudrate, parity, address and period information. For the MODBUS Protocol address information, see the relevant booklet.

8.1.4.2 CANopen Settings

Here you can configure the baud rate, Node ID, Heartbeat, PDO etc. of your device related to the CANopen protocol.

For more information on CANopen, see the EPA300-CANopen booklet.

8.1.5 Keypad Setting (SOUND) **Sound**

When you press any key on your device, you can turn the beep sound on and off from this menu. Use ON to turn the sound on, OFF to turn it off.

8.2 Calibration Menu [CALIB]

8.2.1 Specify Scale Values (SCALE)

SCALE

When your device is calibrated to its factory settings, it operates at a value range of 0-100. That is, the smallest reading on the sensor shows 0 on the screen and 100 on the screen. You can change this scale from this menu.

Use the S-LO for the minimum value of the scale, and the S-HI menus for the maximum value. To change the value, press the PRG key. After specifying the value with the UP and DOWN keys, press the PRG key again to locate the decimal point. Then press the PRG key to confirm the value.

You can use the Fctor menu to expand this scale by multiplying it by a fixed factor. The number of this factor, which is the default value of 1, is multiplied by the values of S-LO and S-HI to determine the scale value.

For example; When you set the S-LO value to 1, the S-HI value to 20 and make the factor 4, your device will run in the 4-80 value range.

OFFSET menu is designed for Loadcell applications. Zero and span points are entered manually and calibrated.

With the **Catch** menu, zero calibration is performed and the current value is automatically drawn to zero. After Catch is selected and confirmed with the PRG key, the value on the display is set to 0.

Value menu; It is designed to perform zero calibration manually and to reverse this value if desired. For example, if you see a value of +0,75 on the device display, you need to enter the value of -0.75 manually to perform zero calibration. After selecting the desired value with UP and DOWN buttons, confirm with PRG button.

Factor menu is used in calibration of span.

For example; In loadcell application, you have a weight of 50 kg, but this value is shown as 49 kg on the device display. In this case, 50/49 is entered into the factor section and the span calibration is performed.

WARNING: Changing the scale value does not change the calibration of your device, it only indicates the displayed value range on the screen. For the calibration of the instrument, 8.2.2.

8.2.2 Manual Calibration Method Determination (CALOP)

CALOP.

Your device has been automatically calibrated during production. If you do not, you can do this calibration according to the sensor. You need to select the calibration method from this menu.

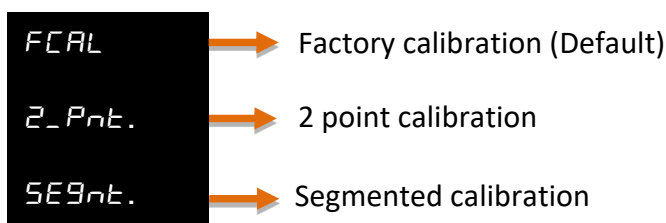

In the 2-point calibration option, only the maximum and minimum points are selected. With the multiple calibration option, you can calibrate your device at up to 10 different points. For example; If the length of the sensor is 40 cm and you want to

calibrate at 5 different points, these points are; There must be 0 cm, 10 cm, 20 cm, 30 cm, and 40 cm points at which the sensor starts.

Select the FCAL option if you want to calibrate your device to factory calibration again.

8.2.3 Number o Calibration (CL.CNT)

CL.CNT.

In this menu that appears when you select the segmented calibration option, you can specify the number of points you want to calibrate the device. It's a maximum of 10.

8.2.4 Automatic Calibration (START)

START

From this menu, you can start your automatic calibration by pressing the PRG key according to the selected calibration method in 8.2.2. section. During the calibration that will start according to your chosen meta; You can see the calibration point to be determined on the first line by the ignored segment number and on the second line the unprocessed value read on the sensor. You can scroll through the segments, ie the calibration points, with the UP and DOWN keys. You can confirm the segment you want to specify with the PRG key while the sensor is in position for calibration. DONE will appear on the screen for a very short period of time.

8.3 Display Menu [DISP]

8.3.1 Choice of decimal point location (POINT)

Point

In the value that appears on the display in run mode, you can set the position of the decimal point in this menu. This value, which is '2' in the factory settings, indicates how many decimal places to display after a call. If you select '0', only the whole number appears on the screen.









8.3.2 Tare Function Settings (TARE)

TARE

In this menu you can define the Tare Function and its properties.

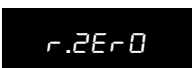
From the **EVENT** menu you can select the Tare Function type:

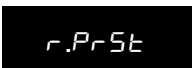
When the unit is in operation mode, each time the UP key is pressed;

		<i>ZERO</i> : Then the value read on the sensor is equal to zero and the Tare state LED is lit.
		<i>PRESET</i> : Then, the value read on the sensor is equalized to the specified value and the Tare status LED is lit.
		<i>REPEATED ZERO</i> : The first time it is pressed, the value read on the sensor is equal to zero and the Tare status LED is lit. When it is pressed later, the read value returns to the state before the key is activated and the Tare status LED is turned off.
		<i>REPEATED PRESET</i> : When pressed for the first time, the value read on the sensor is equal to zero and the Tare status LED is lit. When it is pressed later, the read value returns to the state before the key is activated and the Tare status LED is turned off.

In the **PrSet** option, you can specify the value to be equalized when the Tare key is pressed.

If your EPA300, which is specially manufactured according to your order, has the Digital Tare Input module, you can make settings from the **INPUT** menu under the Tare menu.

The **EDGE** option determines which edge of the edge signal coming from the Tare function is activated. **RISE** for rising edge, **FALL** for falling edge. For example; When you connect this signal to a button, the **RISE** option activates the tare when the button is pressed and the **FALL** option when the button is released after the button is pressed.

In the **FILTR** option, you can specify how many milliseconds the modulated signal is to be controlled. By default, this value is 100 ms.

With the **BUTTON** menu, you can select whether the tare button () on the front can be used. If the button is set to "Off" position, the tare button on the front side is not used, only the rear tare input can be used.

8.3.3 Screen Refresh Rate (REFRS)

REFRS

Indicates how many milliseconds the value displayed on the screen will be refreshed. By default this value is 100 ms; To reduce or reduce the on-screen vibrations, or reduce the duration of your device's response to movement of the sensor.

8.3.4 Blocking the on Screen Volatility (FILTR)

FILTR

Your EPA300 is programmed to display the signals received from its connected sensor in the most accurate way on the screen by processing them with special algorithms. But; You can solve this problem by filtering from this menu in the event of a trembling of the value displayed on the screen due to various reasons such as noise in the vicinity, disturbances in the sensor. There are three different filtering methods for this:

1. **AVRGE (Average Calculation):**

When you activate this filter by turning the STATE option ON, your device will refresh the value that appears on the display after you have read as many values from the sensor as you would select COUNT. For example; COUNT will default to 500, and your device will refresh the value on the screen after you have taken 500 samples from the sensor, that is, after reading it, taking the average of these values. Accordingly, increasing COUNT will reduce flicker on the screen; But your device will slow the response of the sensor to its rapid movement.

2. **LQE(Linear Quadratic Estimation):**

You can also activate this filter, also known as a thick filter, by turning the STATE option ON. If you decrease the default COVARIANCE of 500, the flicker on the screen will decrease; But your device will slow down the reaction of the sensor to its rapid movement.

3. HYS (Hysteresis):

You can activate the hysteresis filter by turning the STATE option ON. With this filter, which has two parameters named Delta and A.Error, the value read from the sensor is not reflected on the screen until it changes to Delta. When the sum of the non-reflected values on the screen is equal to A.Error, the display is updated with the average of these values

8.3.5 Setting the LED Bar `bar.gr.`

The led bar on the display normally moves from left to right as the value read from the sensor increases. You can change this direction as you like or move the scale value in reverse direction



`INVERS` → If you want the led bar to move from right to left, enter the Invers menu and set the normally OFF position to ON and confirm with the PRG and exit.

`SCALE` → You can move the led bar between the values you want, for this purpose enter the SCALE menu under the Bar.Gr. menu and turn the on position to the off position. S-LO. and S-HI. menus will be added under the Bar.Gr. menu. Enter the S-HI value for the end of the led bar and S-LO value for the start of the led bar and confirm with PRG.

8.4 Secure Menu [SECUR]

8.4.1 Hide Menu (HIDE) `HIDE`

You can hide the menus ON you do not want the operator to see your device to use them.

- `Hd.ALL` → All menus except Secure are hidden.
- `Hd.OUT` → The Output menu is hidden.
- `Hd.CLb` → The Calib menu is hidden.
- `Hd.dSP` → The Display menu is hidden.
- `Hd.FOU` → The Quick Set change menu is hidden. See 7.3.

8.4.2 Lock Menu (LOCK)



If you have not set a password before, you will see NPASS in the display when you enter this menu. Press the PRG key to set the desired password here. Then use the DOWN and UP keys to select the menus you want to lock. Definition of the menus are same as 8.4.1. Menu Hiding section.

8.4.3 Setting the Password (PASS)



Use this menu item to set a password or to change the password you have previously set. If no password was previously set; When you enter this menu, the display will show NPASS. Press the PRG key to set the desired password here. If the password has already been set; The display shows PASS? Will appear and you will be asked to enter this password. After inputting the password, the display will show NPASS. You can specify your new password here and confirm it with the PRG key.

8.4.4 Return the Factory Settings (FTRY)

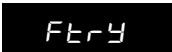

You can return your EPA300 to factory settings from the time box you desire. Press the PRG key to return to the factory settings. You need to enter 12345, which is the factory password for PASS password menu.

8.4.5 Restart the Device (RESET)



In any case, press the PRG key to come back to this menu to restart your device. The device will automatically power off and on and start working.

NOTE: The EPA 300 can be used with the instrument panel only, without the need for relay outputs.

ORDER CODING:

When ordering your EPA 300 process controller, you can use the following coding format.

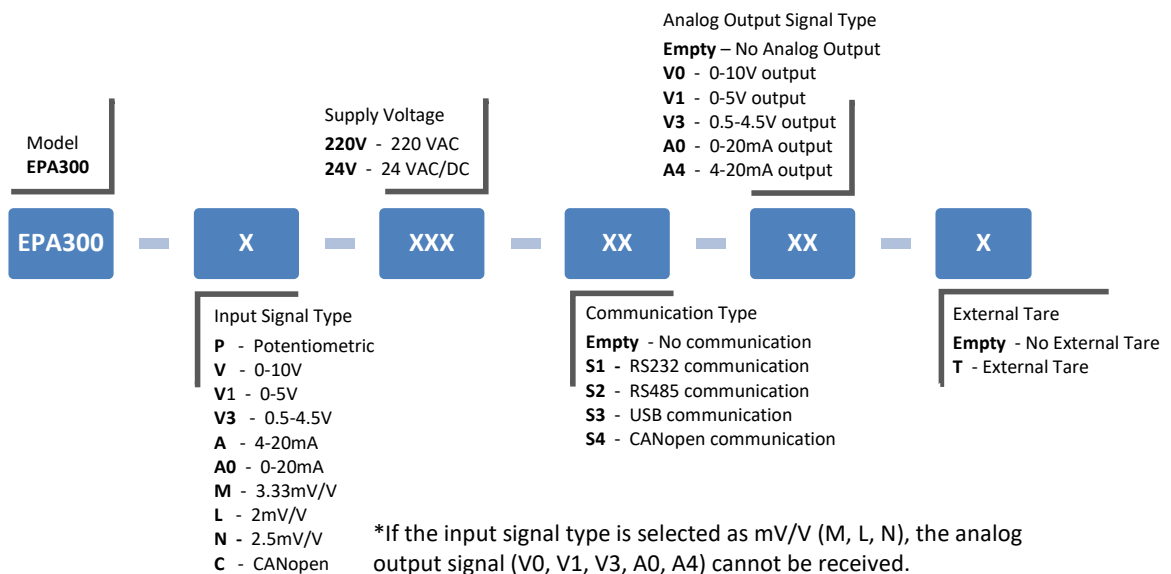

* Optionally **Dual Analog Output** can be requested. In this case, it is necessary to add "2" code at the beginning of the desired signal output at order coding.

Sample Product Code: EPA300-P-220V-S2-2A4-T

9. WARRANTY DOCUMENT

Seller Company's:

Name:

Address:

Phone:

FAX:

E-mail:

Invoice Date and No:

Delivery Date and Address:

Signature, Cachet

Product Brand: ESKON

Product Code: EPA-300

Serial No:

Warranty Time: 2 Years

This product is guaranteed for 2 years against manufacturing defects.

Non-warranty situations:

1. Mechanical damages
2. Damages in case of transportation
3. User errors

Other cases than these cases are under the manufacturer's warranty.